

规格书

WWT118-01-252

6M 工业镜头

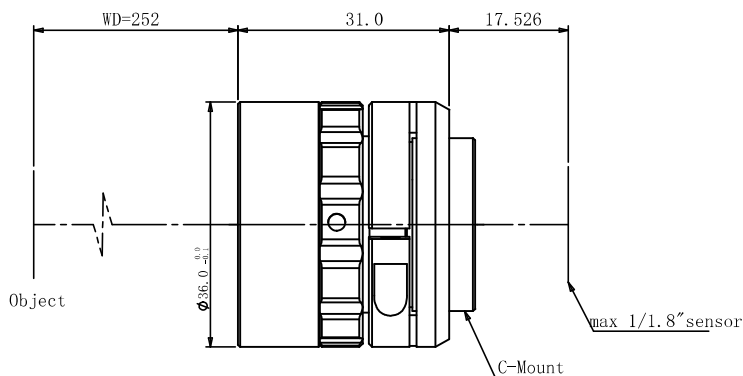

光学参数

放大倍率 β (x)	0.1
物方工作距 WD (mm)	252
支持 CCD 尺寸 (Φ mm)	9(1/1.8")
像方 F/#	5.6
焦距 (mm)	25.04
数值孔径 NA	0.00894
物方分辨率 (μ m)	37.5
物方景深 DoF (mm)	44.8
像方 MTF30 (lp/mm)	172
TV 畸变 (%)	-0.015

视野范围 (mm × mm)

1/1.8" (7.13x5.37)	71.3x53.7
1/1.8" (7.43x4.9)	74.3x49.0

机械参数

相机接口	C
镜头总长 (mm)	31.0
是否同轴光 / 可调光栏	否 / 否

